

# Carrier of NRM in oceanic basalt studied by continuous thermal demagnetisation

M. Wack, M. Alexutin, J. Matzka

University Munich, Germany (wack@geophysik.uni-muenchen.de)



# An example from the South Atlantic

35°W 7°S

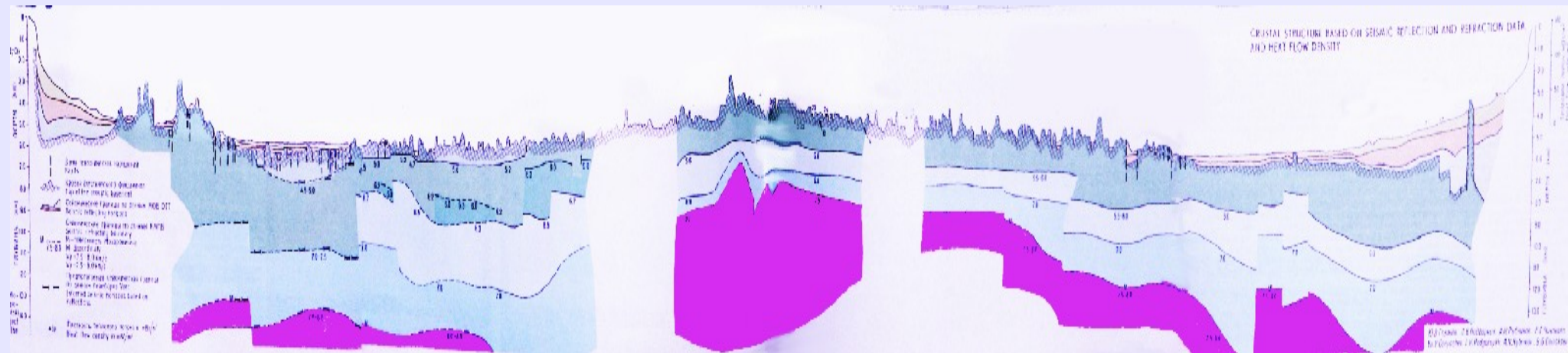
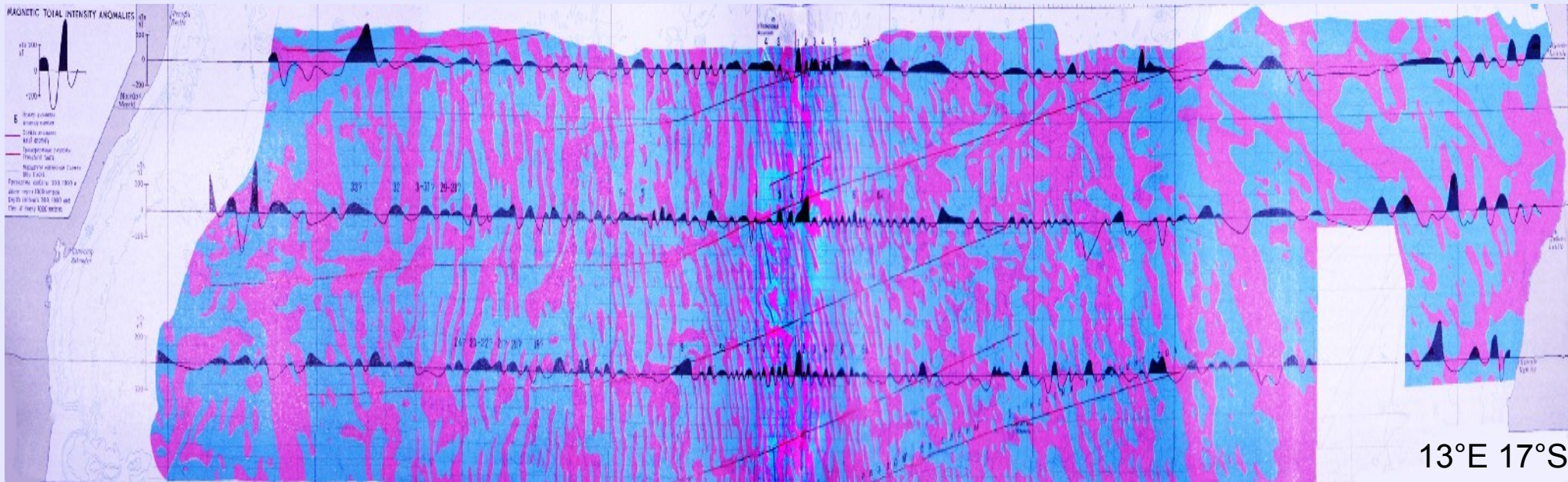

Sketches taken from the International Geological-Geophysical Atlas of the Atlantic Ocean

wack@geophysik.uni-muenchen.de

# Oceanic basalt is a peculiar magnetisation carrier

- Small amplitudes around 20 Ma

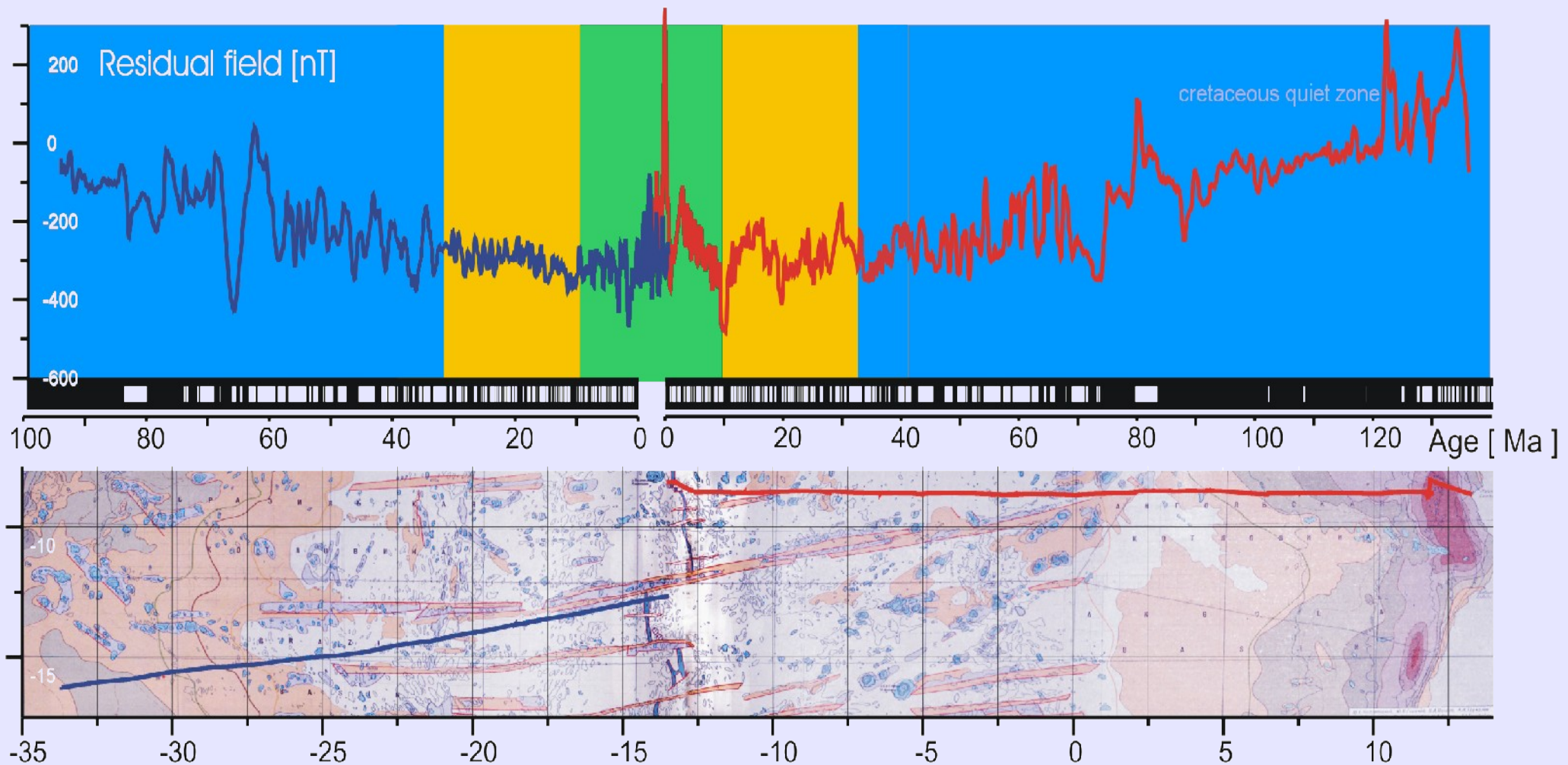

data provided by National Geophysical Data Center (NGDC)

# NRM intensities of ocean basalts

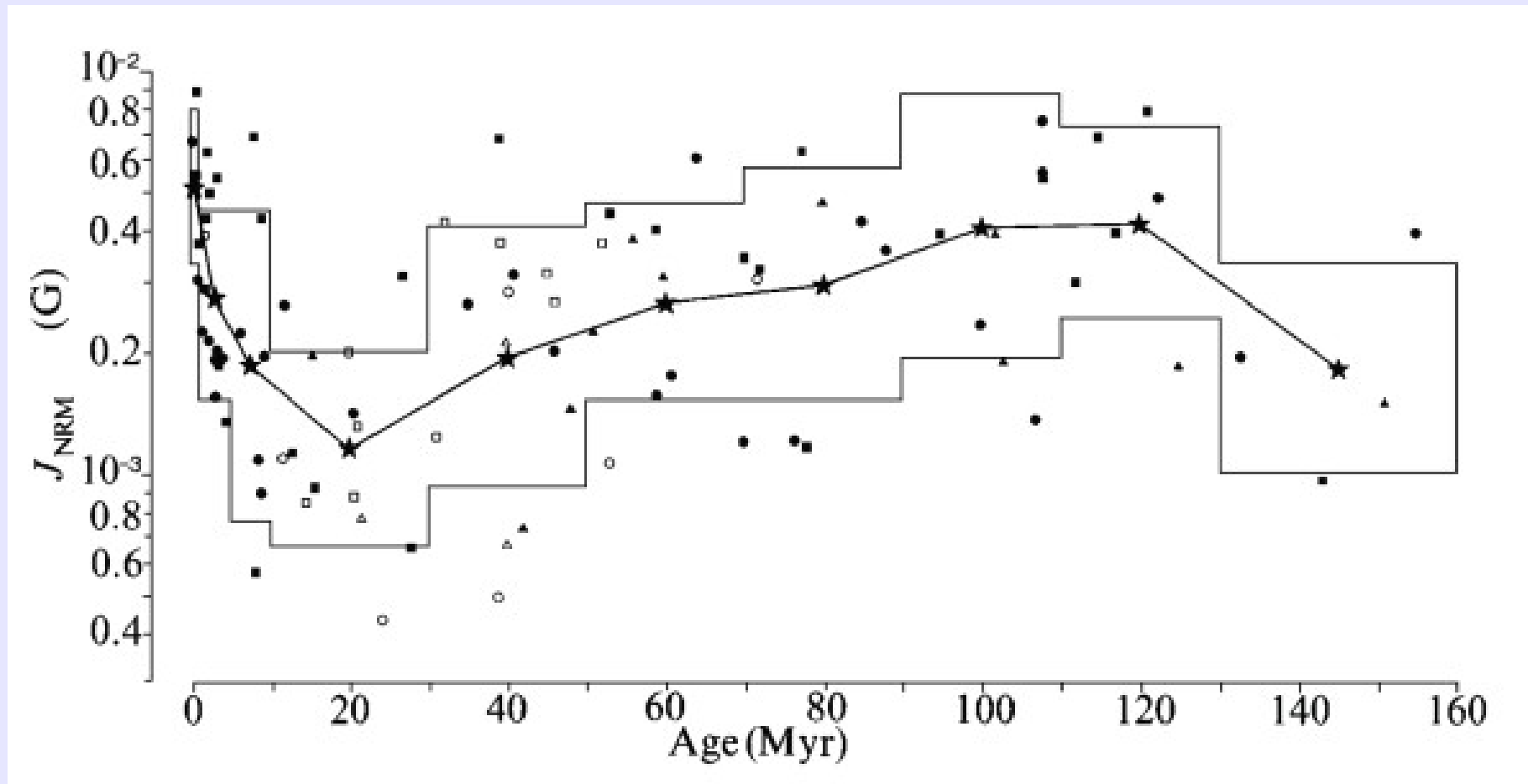

Bleil and Petersen, 1983

# At the mid-ocean ridge...

- High marine magnetic anomalies
- High saturation magnetisation
- Curie temperature approx. 150 °C
- Carrier of the NRM is weakly magnetized titanomagnetite

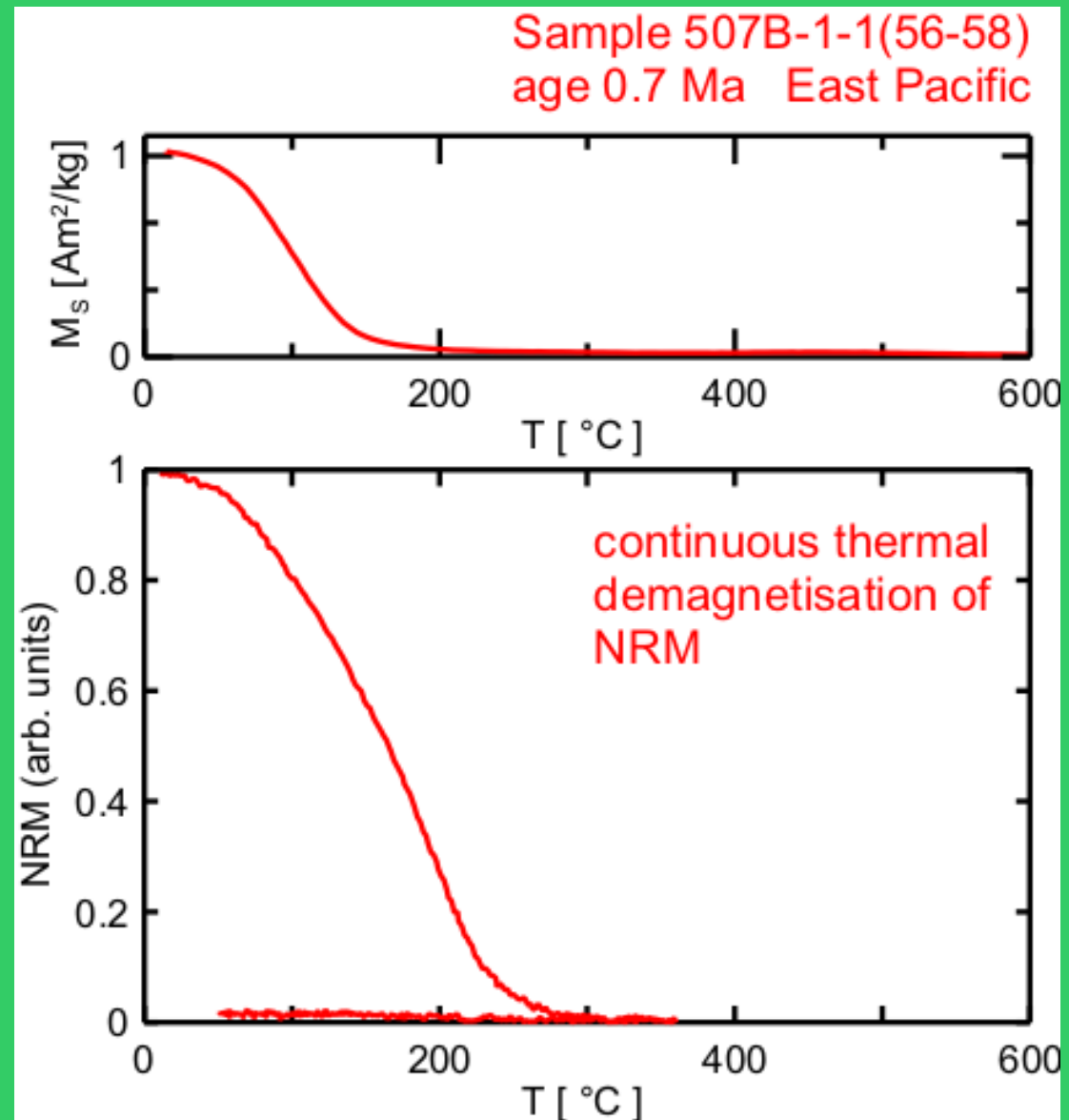
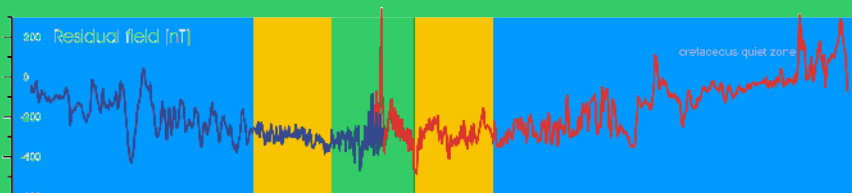

# In 10 to 35 Ma old oceanic crust

- Low marine magnetic anomalies
- Low saturation magnetisation
- Curie temperature approx. 300 °C
- Carrier of the NRM is titanomaghemite

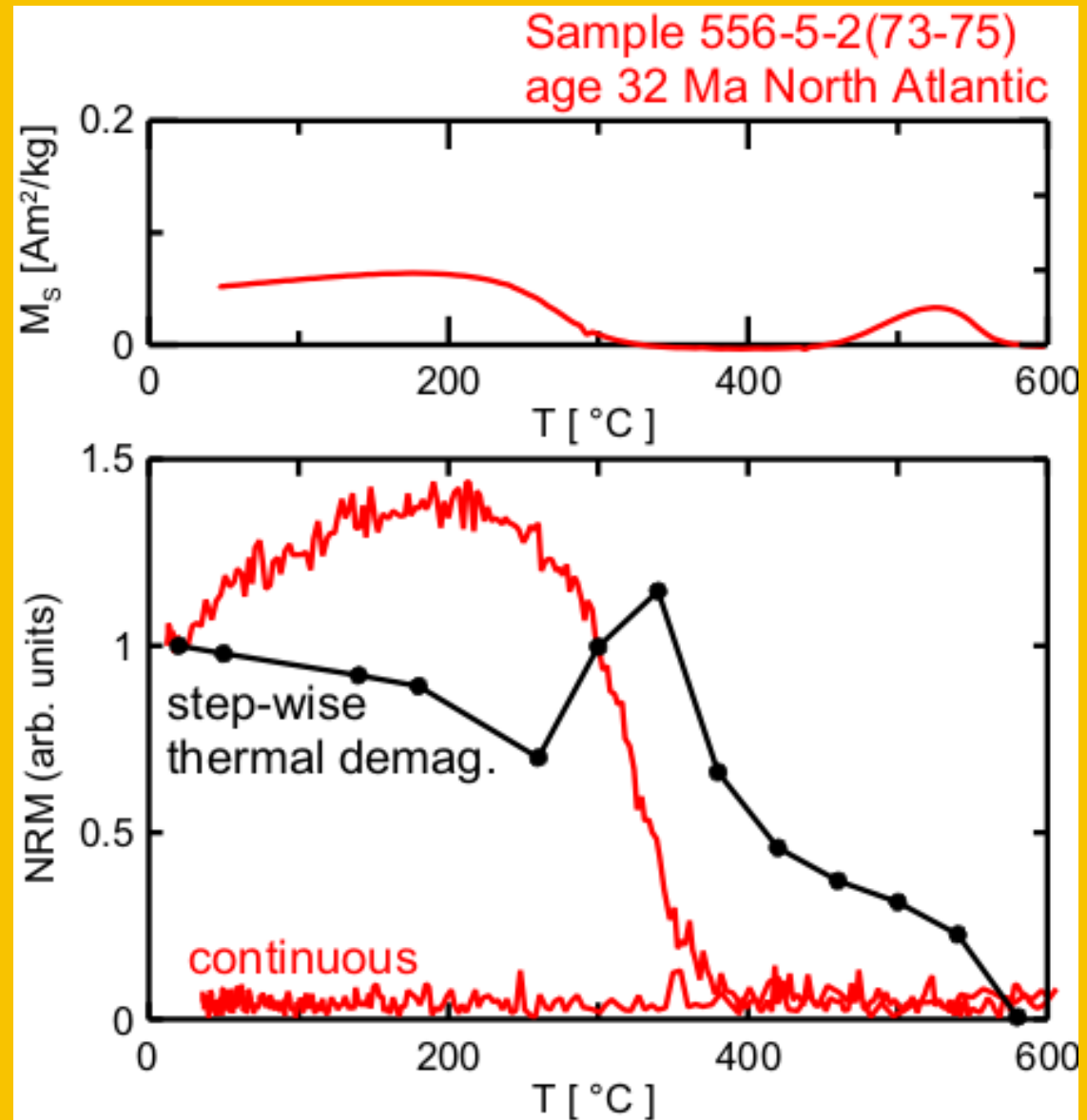
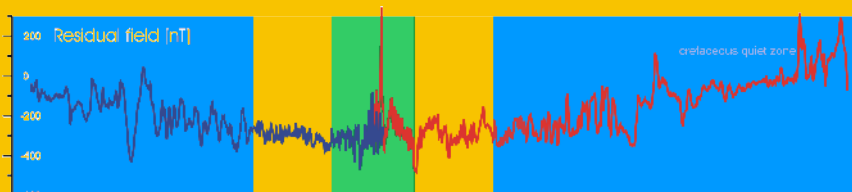

# In oceanic crust older than 35 Ma

- High marine magnetic anomalies
- High saturation magnetisation
- 2 (?) Curie temperatures
- Carrier of the NRM is magnetite

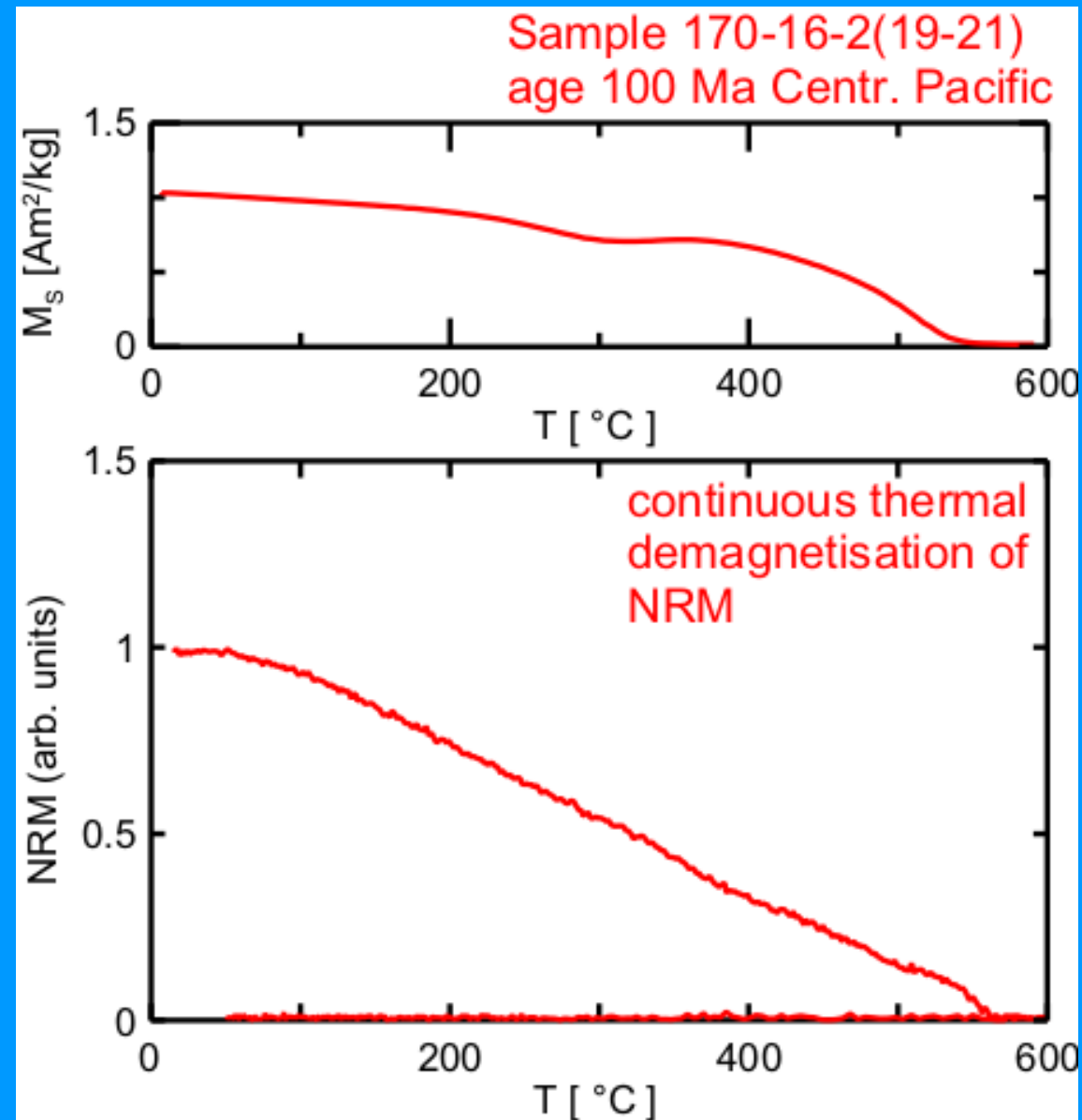
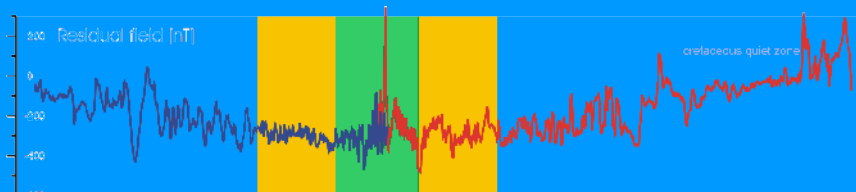

# Classic stepwise vs. continuous thermal demagnetisation

■ Heating    ■ Cooling

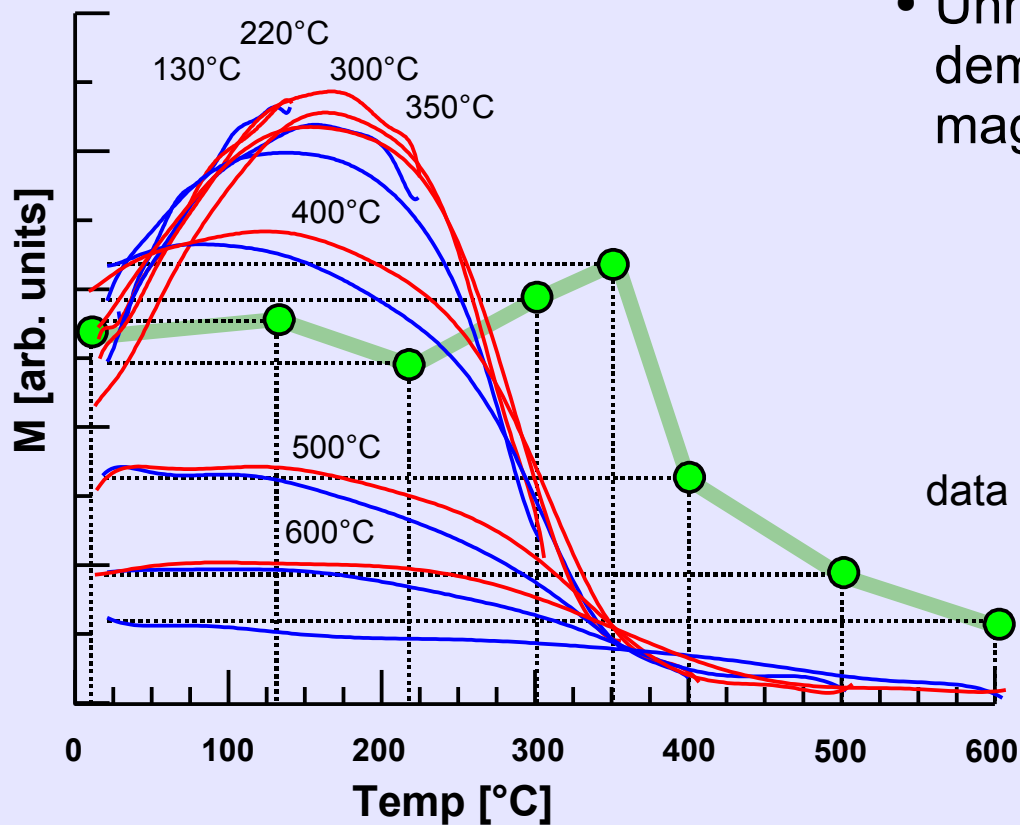

- Most paleomagnetic data by stepwise thermal demagnetization
- Unnoticed effects in stepwise demagnetization due to alteration of magnetic minerals

data from ODP sample 9-0079-017R-01w 102-106



# Classic stepwise vs. continuous thermal demagnetisation

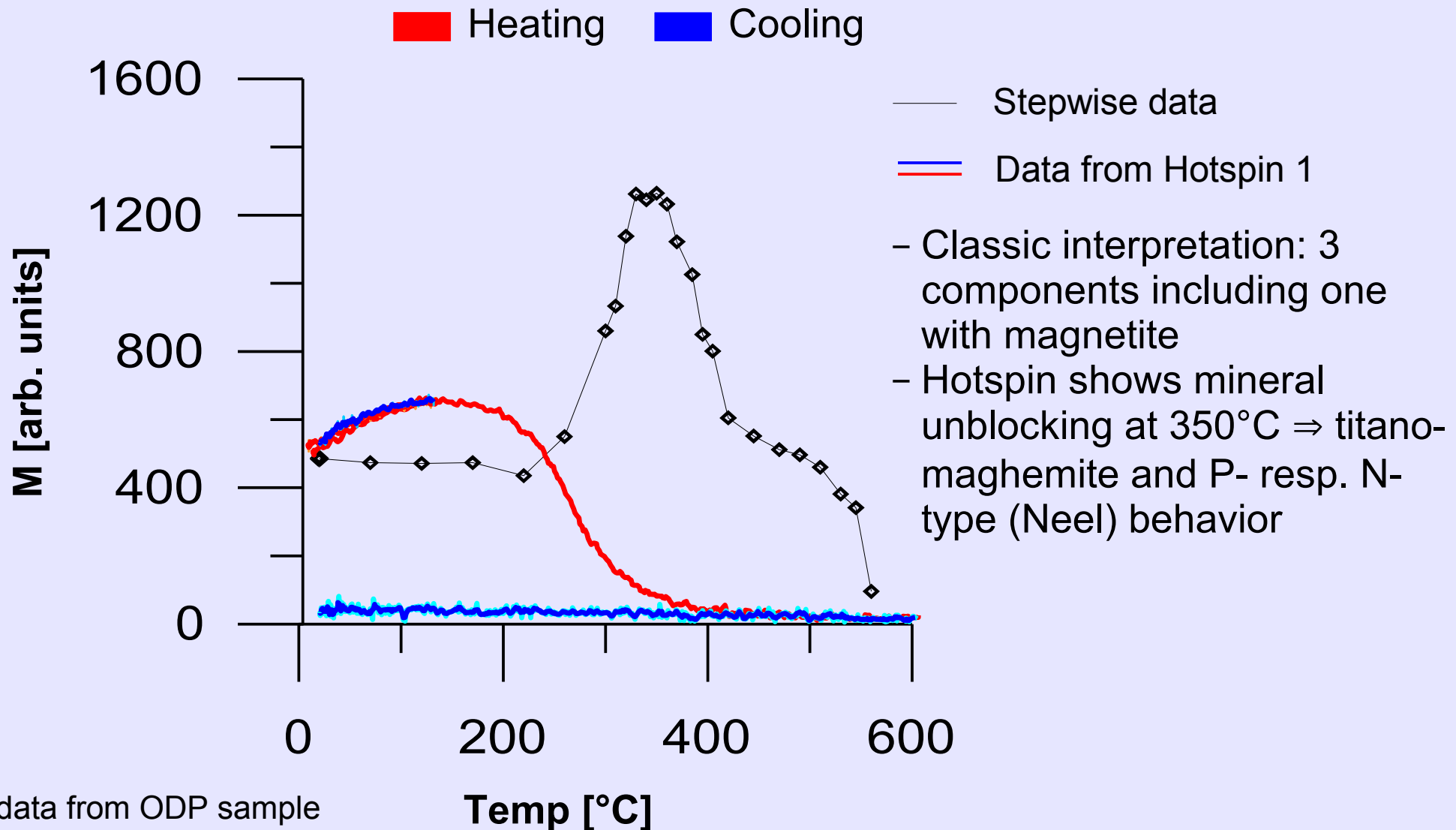

data from ODP sample  
9-0079-017R-01w 102-106

# The Idea of the Hotspin 2 Instrument

- Off-axis spinner magnetometer
- Fluxgate sensors
- Expected magnetic signals similar to those measured over magnetic anomalies in the subsurface

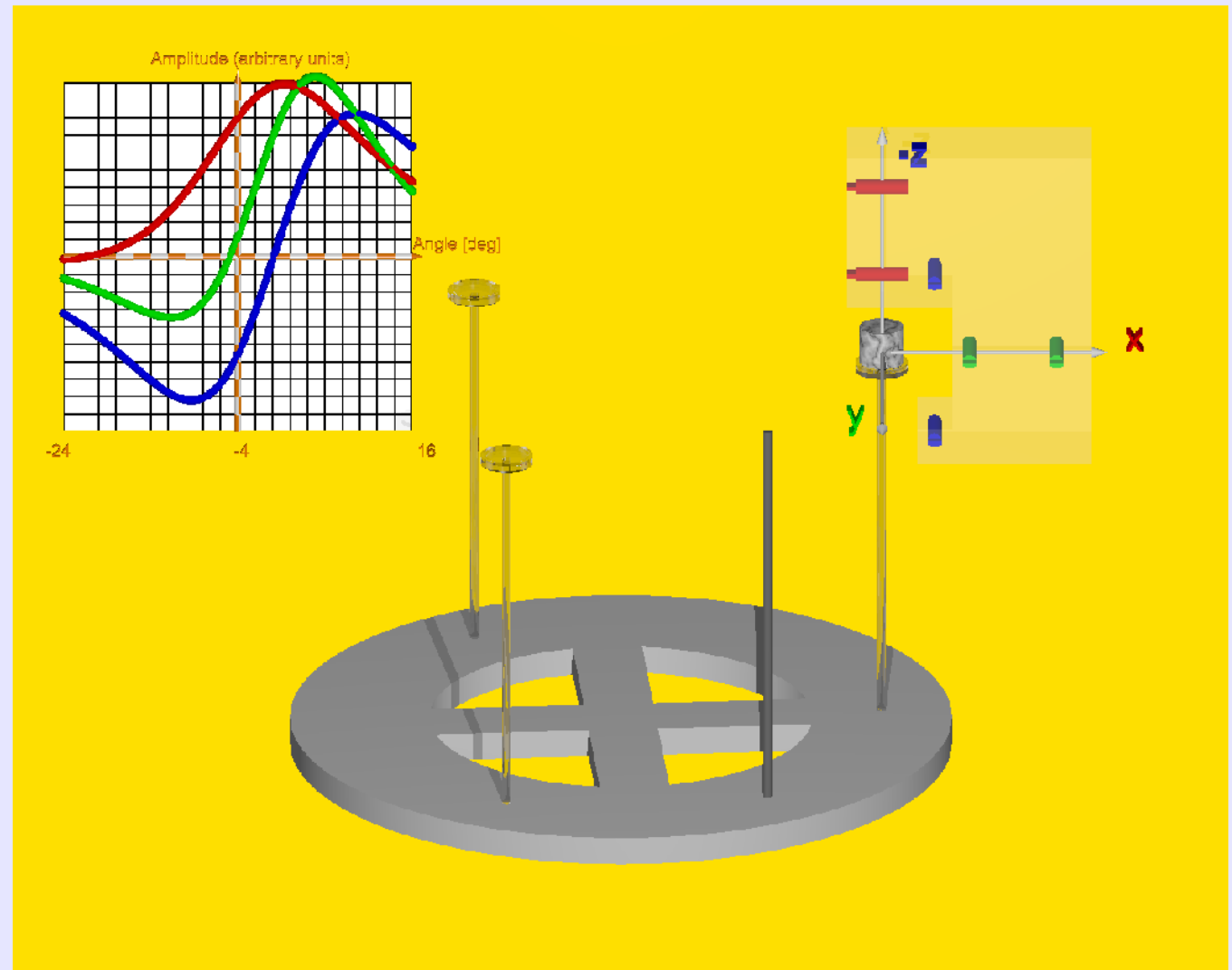

video

# The Hotspin 2 instrument under construction ...

- Specimens and temperature sensor moving on circular ( $R=15\text{cm}$ ) path in a circular oven
- Heating by hot air (details later)
- All electrical powered or magnetical stuff away from samples and sensors
- External field compensated by three Helmholtz coils

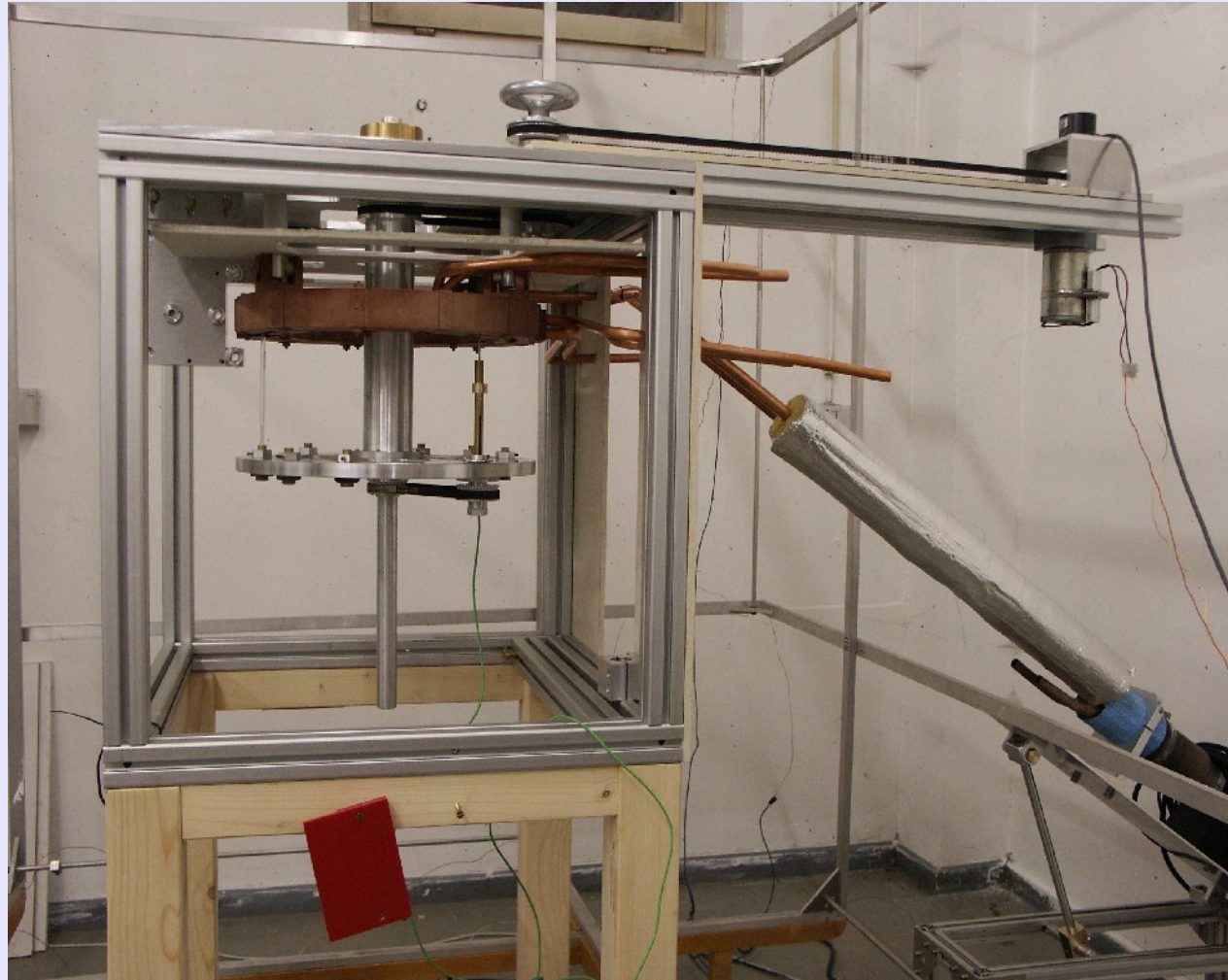

# Circular Oven

- Hot air runs through copper pipes on the in- and outside of the ring
- Samples are primarily heated through radiation
- Air circulation is optimized for a good temperature dispersion
- No magnetic effects on samples
- At the moment temperatures up to 400°C can be achieved

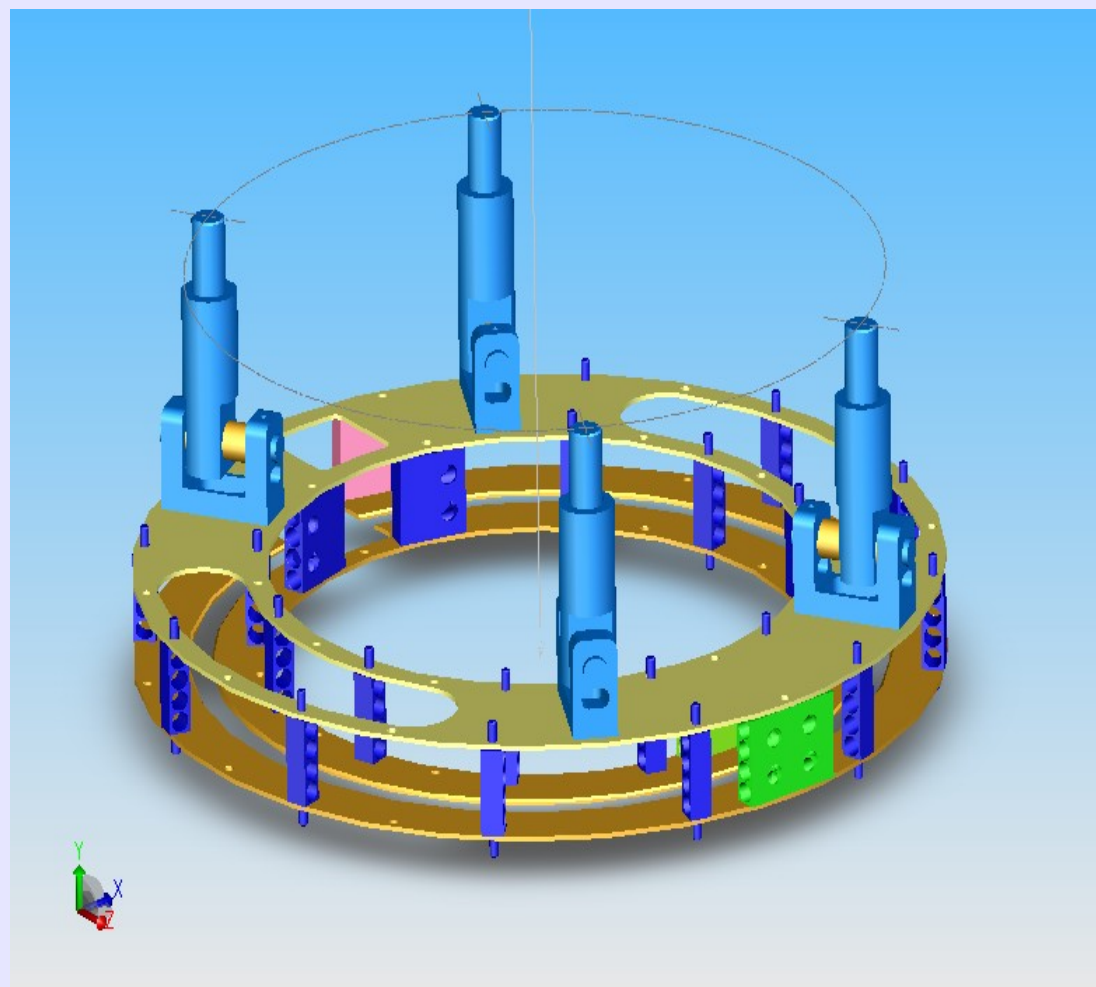

# Heating

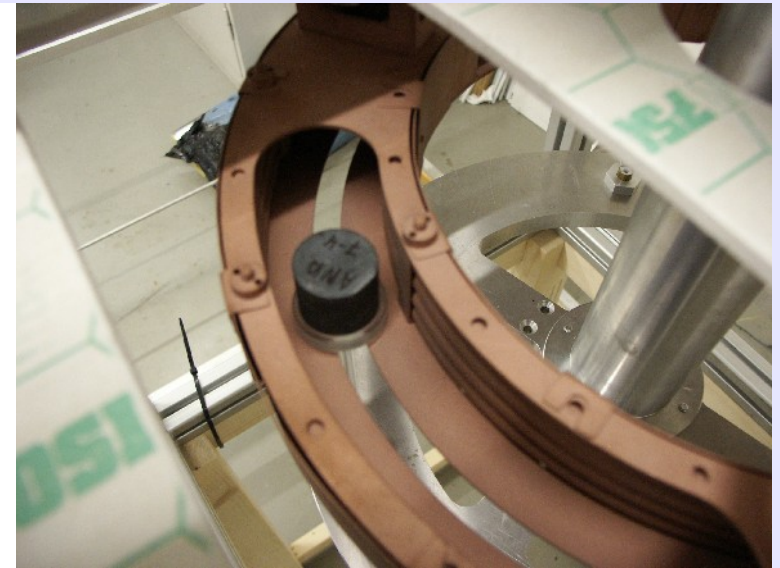
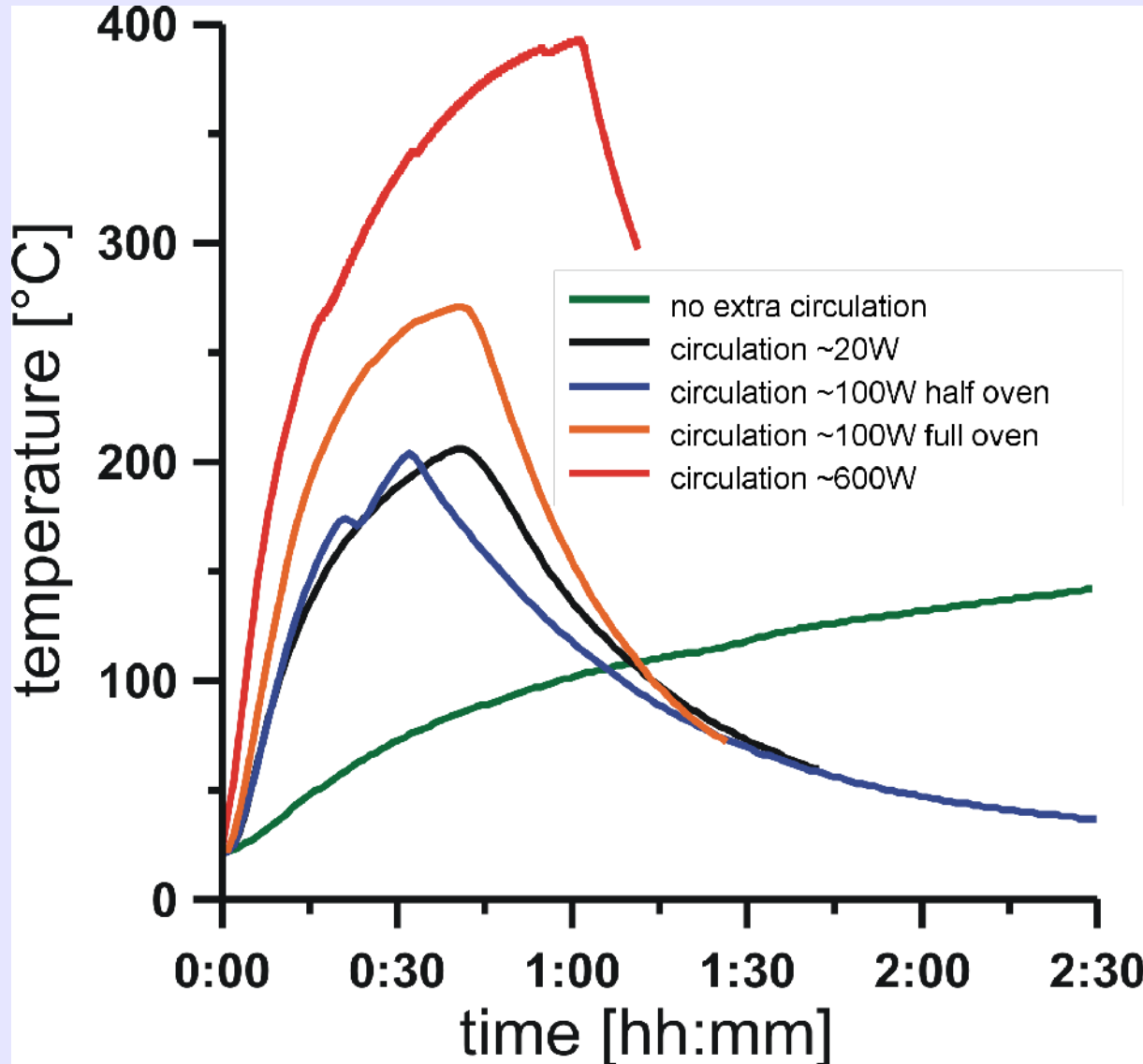

# Sensor Arrangement

- Optimized for:
  - Maximum sensitivity
  - Minimum interference
  - Good separation of magnetisation components

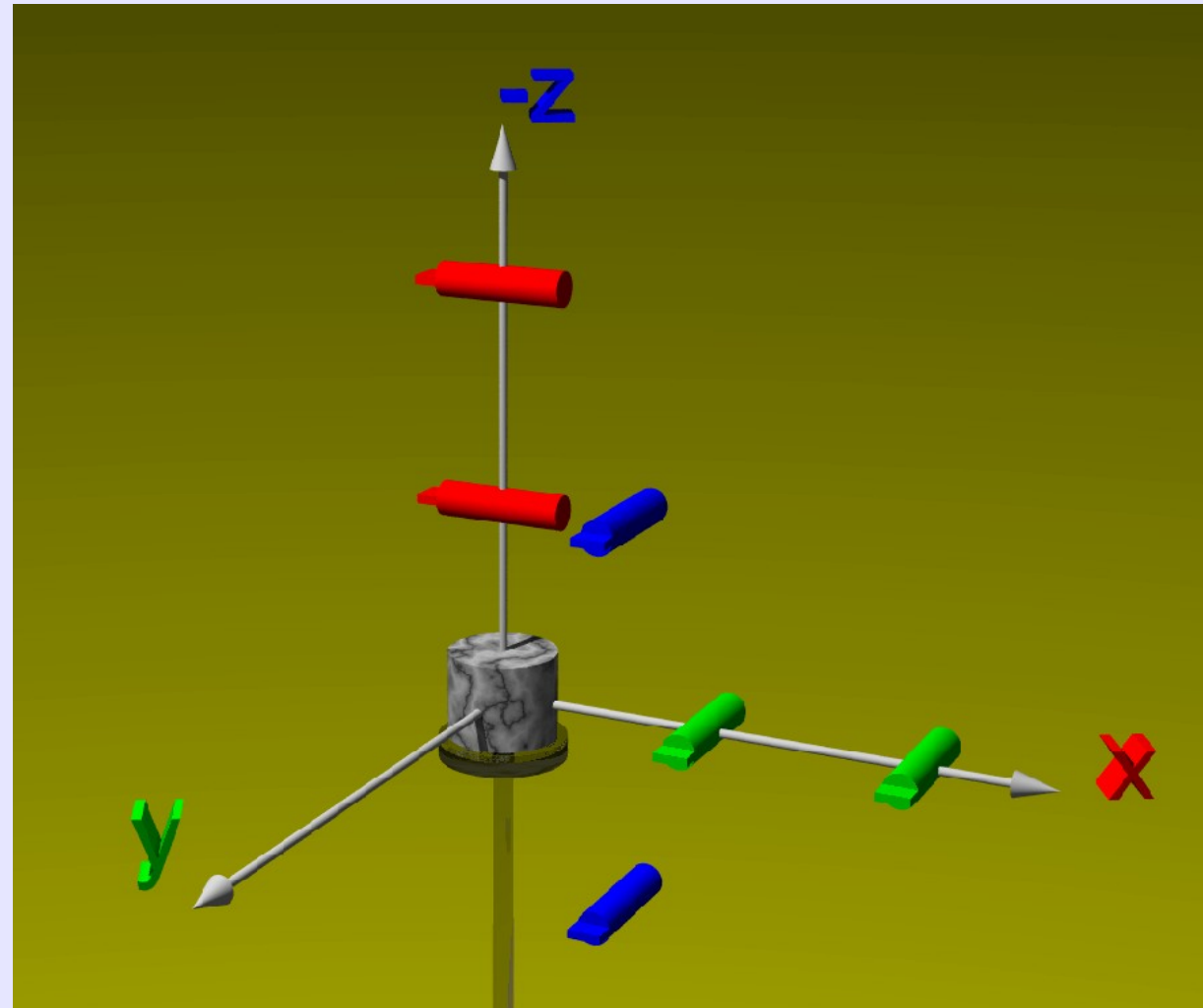

# Sensitivity

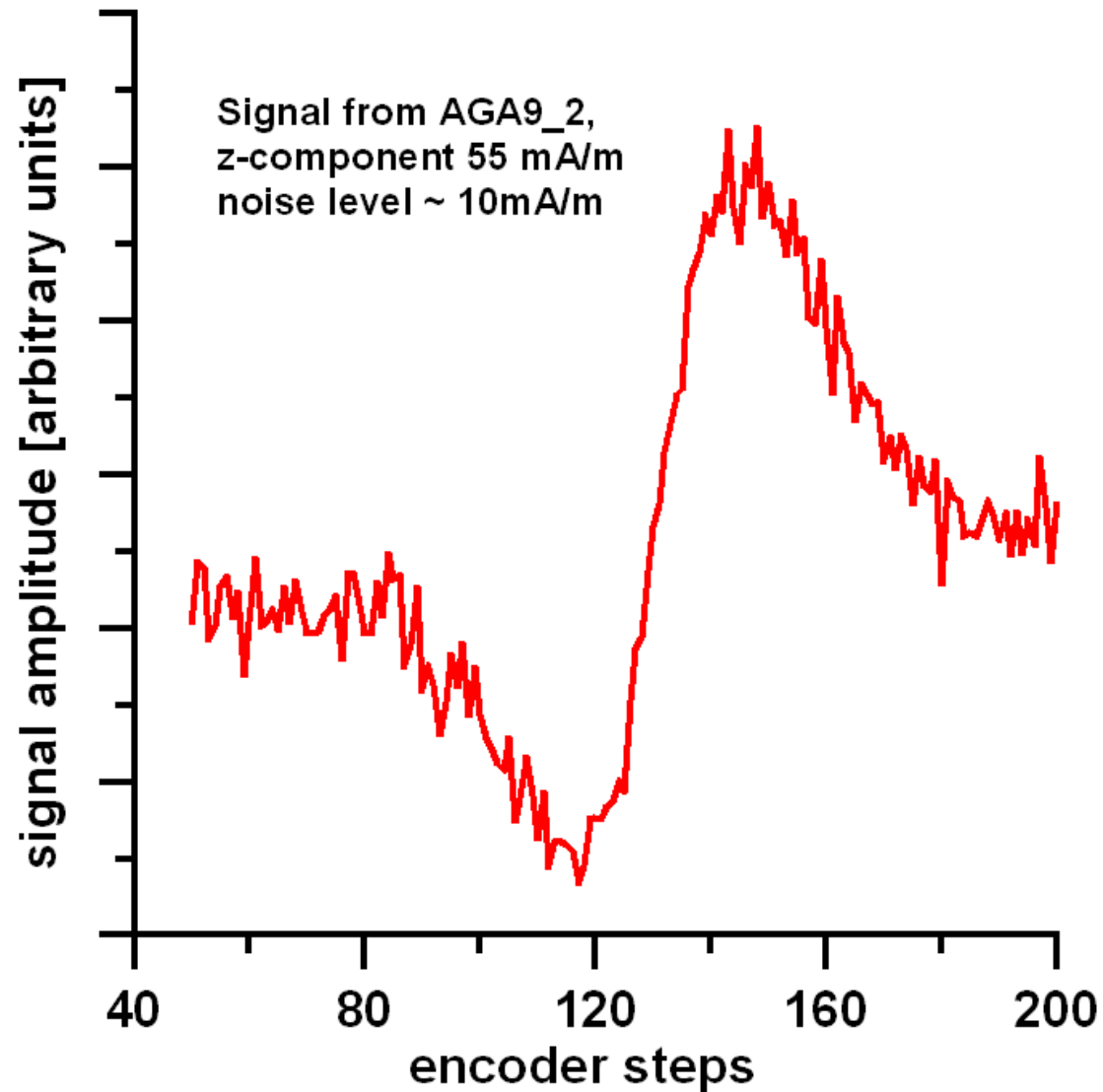

Thank you!